



重慶大學  
CHONGQING UNIVERSITY



# **Multi-functional Physical Model Testing System of Deep Coal Petrography Engineering**

**Presented by: Prof. Lu Yiyu**

**State Key Laboratory for Coal Mine  
Disaster Dynamics and Control**

**Chongqing University**

**2019.06.23**



# Outline

1. Introduction
2. Development of coal and gas outburst experimental system
3. Features of the system
4. Coal and gas outburst simulation experiment



# 1. Introduction

## □ Research Backgrounds

- ◆ The geological conditions of coal mining in China are much complex, High-gas mines account for around **70%**.
- ◆ Coal and gas can be easily ejected suddenly during coal mining under the gas pressure and in-situ stress, i.e., **coal and gas outburst**, resulting in a large number of casualties and property losses.

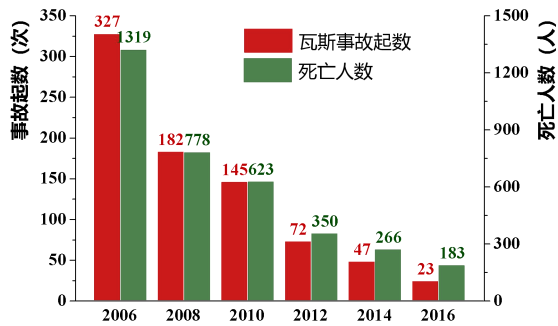

The death toll of coal mine accidents

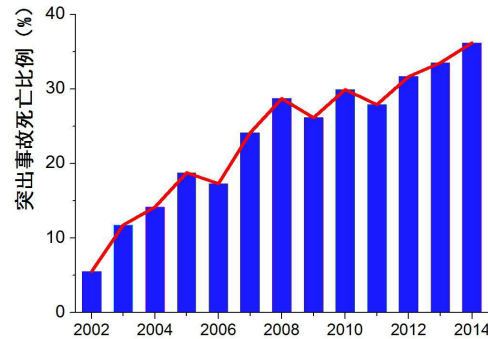

The death ratio of outburst accidents in coal mines

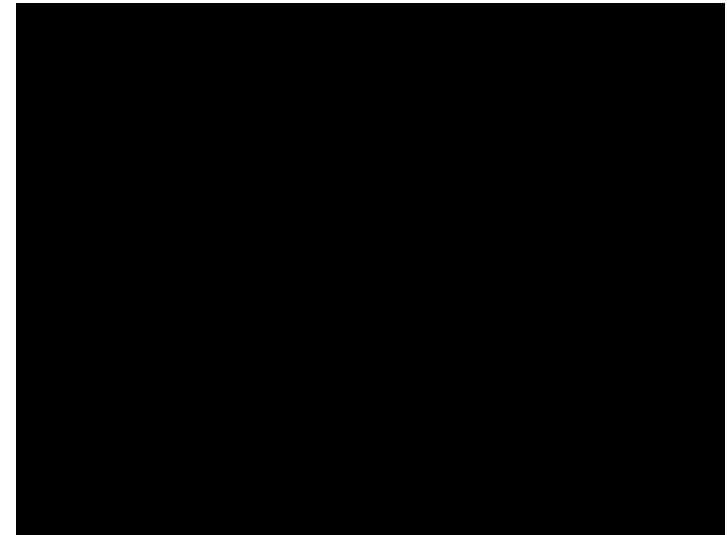

## □ Research Aims

- ◆ Coal and gas outburst is a very complicated dynamic disaster, **with many influence factors and complicated reasons.**
- ◆ It is **a worldwide problem** to study the outburst mechanism under various geological and mining conditions.

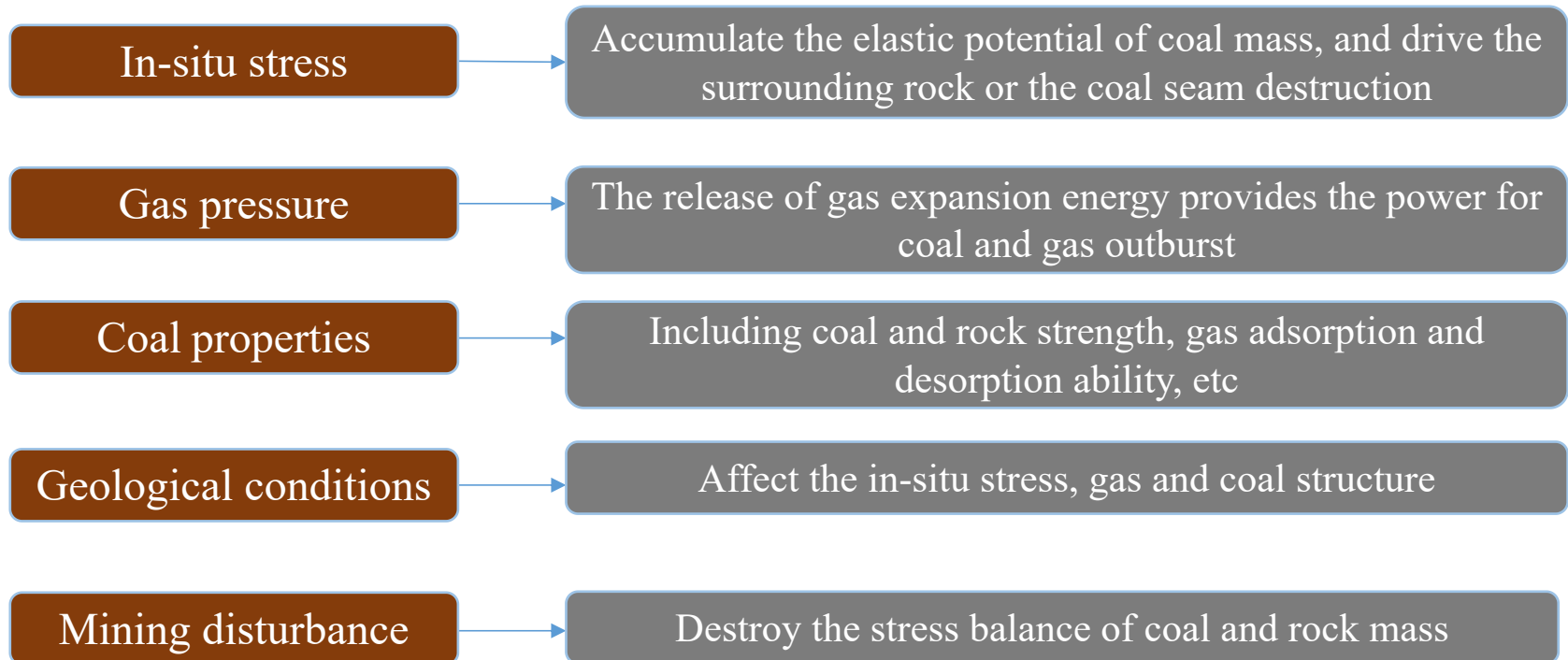

# 1. Introduction

## □ Research Aims

- ◆ The existing hypotheses fail to explain the outburst mechanism, therefore, further study is needed on **the basis of experiments**.

Field tests
<ul style="list-style-type: none"><li>• Complicated outburst conditions</li><li>• Low repeatability</li><li>• Difficult and dangerous</li></ul>

Simulation tests
<ul style="list-style-type: none"><li>• Controllable experimental conditions</li><li>• High repeatability</li><li>• Safety testing procedure</li></ul>

- ◆ The development of coal and gas outburst experiment equipment that can realize the **solid stress loading, gas stress loading, and excavation disturbances** is urgent.



# Outline

1. Introduction
2. Development of coal and gas outburst experimental system
3. Features of the system
4. Coal and gas outburst simulation experiment



### Existing equipment

#### (1) Sample Size

- Small sample size, strong boundary effect
- Fail to simulate the geological conditions and excavation process



#### (2) Device Size

- Large counter force is required
- Small gas storage space

#### (3) Sealing performance

- Poor sealing effect using glue or bolts



### Existing equipment

#### (4) Stress loading

- True triaxial loading is seldom adopted
- Less loading cylinders, uneven stress distribution and low loading precision



#### (5) Simulation of disturbance

- Quick release mechanism is used without considering the impact of excavation disturbances on the coal and gas outburst



### □ Basic requirements for new developed equipment

Some basic requirements are proposed and new equipment is developed.

- **Size:** Scientific and reasonable sample size is used to weaken the boundary effect, to simulate the geological structure and to improve the similarity.
- **Sealability:** Strengthen the sealing effect of the experimental device to ensure the stability of high gas pressure in the model cavity.
- **Loading:** True triaxial loading is adopted with high loading stress, more load cylinders are used to improve the loading precision.
- **Gas storage:** Improve the effective space utilization to ensure the sufficient gas outside the sample.
- **Mining Disturbance:** The excavation device is added to obtain the precursor information of coal and gas outburst



**Multi-functional physical model testing system of deep coal petrography engineering**

### Multi-functional physical model testing system of deep coal petrography engineering

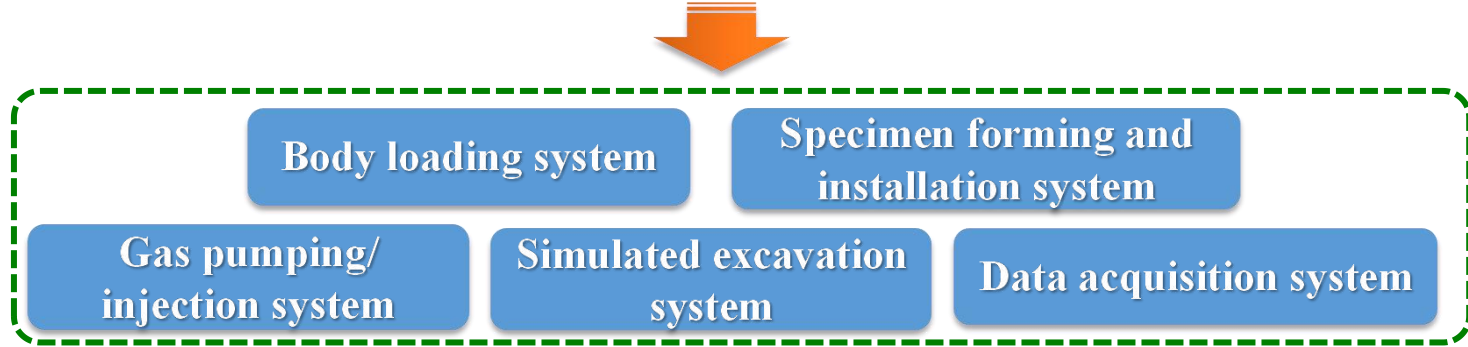

### □ Body loading system



#### (1) Main device

- Steel cylinder structure of “**round exterior and square interior**”;
- 20 horizontal high-strength rods are arranged in the hoop direction;
- Design **an excavation channel** at one end.

#### (2) Hydraulic servo loading system:

- Including 4 active loading faces, 72 loading units, 432 uniform loading cylinders;
- **Even distribution** of boundary loads;
- The experimental model can be **layered and stepped loaded**.

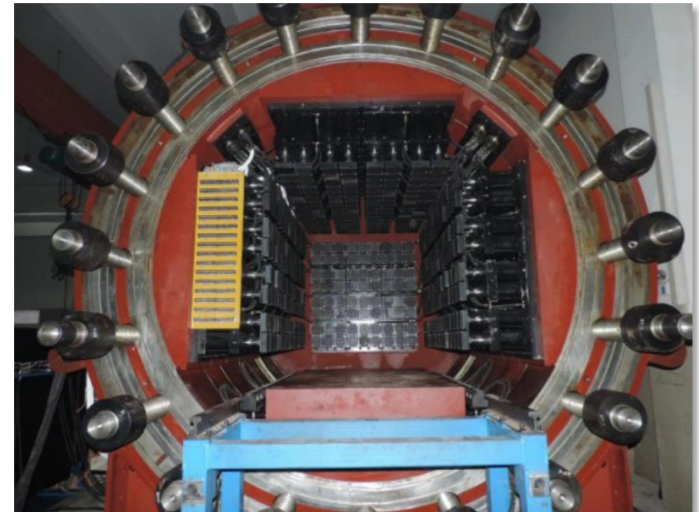

### □ Specimen forming and installation system

- The maximum sample load: **5 MPa**;
- Maximum sample size:  
**2060 mm × 1200 mm × 1200 mm**;
- The sample is sent into the experimental chamber **automatically** by the driven car along the track.



Sample preparation mold box



Model forming press

### □ Gas pumping or injection system



#### (1) Gas pumping system:

- Two sets of vacuum pumps in parallel;
- The vacuum in the chamber can reach 140 Pa.

#### (2) Gas injection system:

- Carbon dioxide injection system (mainly-used);
- Compressed air injection system (check sealability).



### □ Excavation simulation system

- ◆ Two sets of excavation machines are equipped to meet the requirements of drilling under different working conditions.

#### (1) Hard rock hole drilling rig:

- ZDY-750 hydraulic tunnel drill;
- Suitable for coal seams with **high consolidating coefficient**.

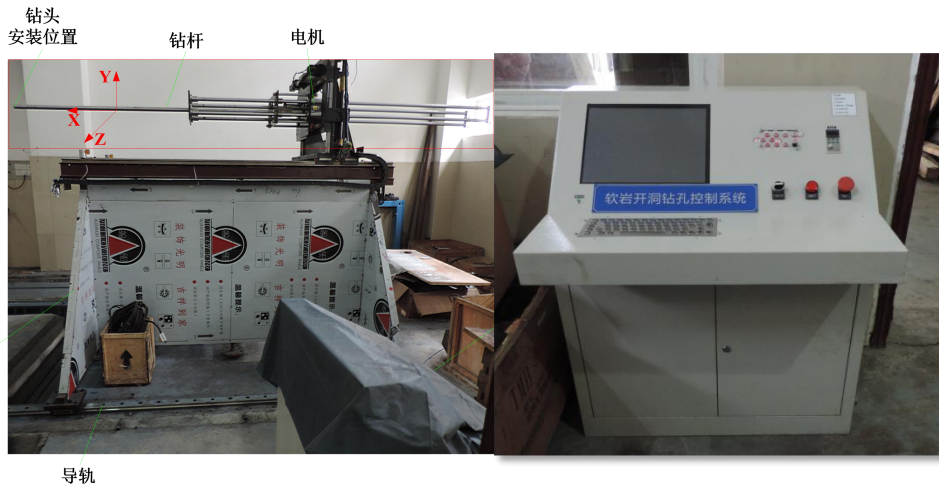

#### (2) Soft rock hole drilling rig:

- Suitable for **soft materials**;
- Automatically controlled by computer software;
- Adjustable in X, Y and Z directions.

### □ Data acquisition and monitoring system

#### (1) Data acquisition system

- 304 data acquisition channels;
- Stress, strain, displacement, gas pressure, temperature, acoustic emission signal.

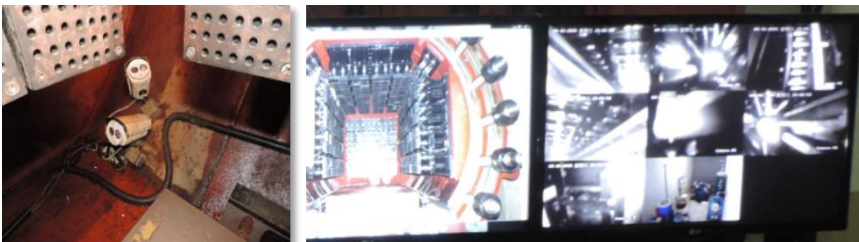
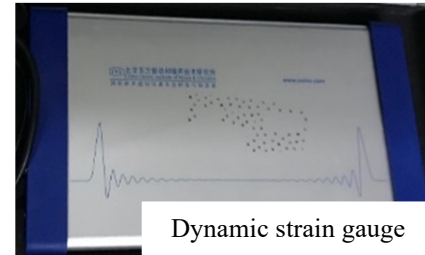
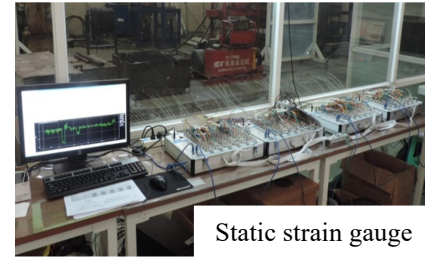

#### (2) Monitoring system

- **Visual observation system** inside the chamber;
- Recording experimental phenomena in real-time;
- Monitoring the internal operation of the system

### □ Main technical parameters

Subsystem	Technical parameters
Body loading system	Setup Dimensions: 4950 mm × 3780 mm × 3930 mm Sample size: 2060 mm × 1200 mm × 1200 mm
Hydraulic servo loading system	Maximum loading stress: 10MPa Precision: $\pm 2\%$ F.S
Gas pumping or injection system	Maximum sealing pressure: 5 MPa
	Precision: $\pm 2\%$ F.S; maximum vacuum degree: <140 Pa
Excavation simulation system	Drilling depth: 2400 mm Diameter of drilling: 0~300 mm
Data acquisition and monitoring system	High-speed camera PCI-2 Acoustic emission system Multichannel temperature data recorder Gas and solid pressure sensors Static/dynamic strain gauge



### □ Main functions of developed system

**Following studies can be carried out:**

- ◆ Coal and gas outburst;
- ◆ Rock burst test;
- ◆ Hydraulic stimulation of coal seam;
- ◆ Surrounding rock deformation and failure of underground constructors;
- ◆ Supercritical CO<sub>2</sub> fracturing.





# Outline

1. Introduction
2. Development of coal and gas outburst experimental system
3. Features of the system
4. Coal and gas outburst simulation experiment



## ❑ Steel cylinder structure of “round exterior and square interior”

### (1) Main device structure:

- Avoid local stress concentration;
- Increase the stiffness and bearing capacity of the system;
- No need to provide large reaction device.

### (2) Setup chamber:

- Large sample size;
- Simulate geological structures;
- Weak boundary effect.

### (3) Internal arrangement:

- Improve the space utilization of the device;
- Increase the gas storage space outside the sample;
- Ensure the adequate air source and the supply capacity of gas in short time.

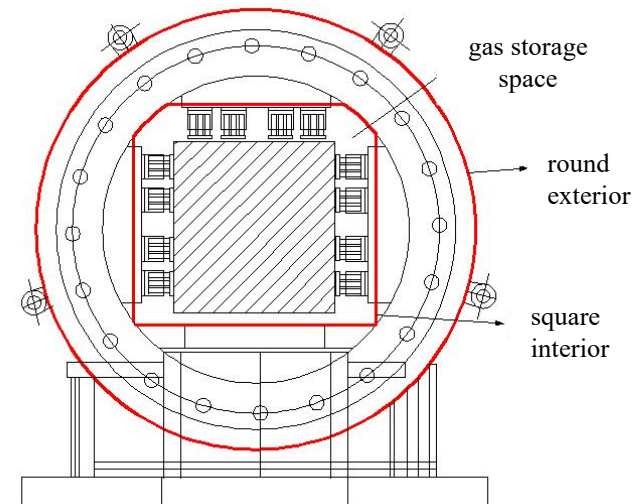
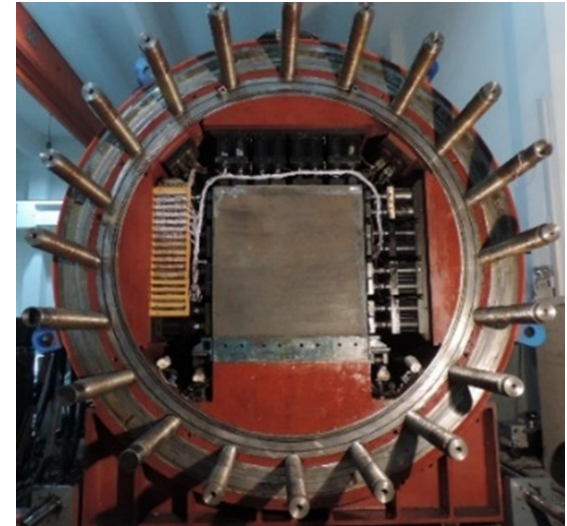

Schematic of gas storage space

# 3. Features of the system

## Multiple sealing designs

### (1) Sealing of the whole setup

#### Positioning ring and sealing ring

- Each section has 1 positioning ring and 2 sealing rings;
- Sealing of bearing ring clearance.

#### Hydraulic puller

- Prestress is applied to 20 ring-arranged rods;
- **Ensure the sealing effect** of the inner chamber.

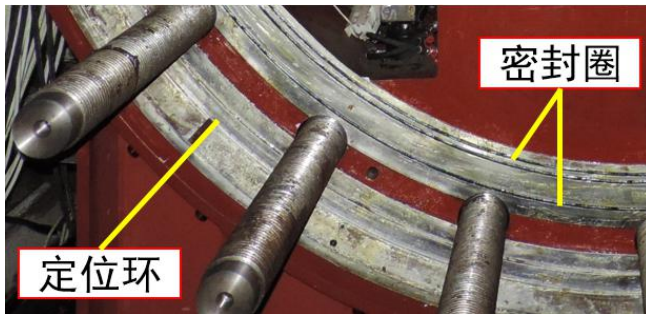

Positioning ring and sealing ring



Hydraulic puller

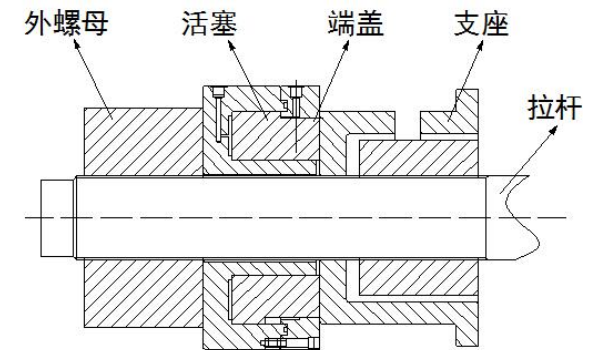

## 3. Features of the system

### □ Multiple sealing designs

#### (2) Sealing of oil and line outlets

- Sealing flanges are situated in **oil circuit lead-out hole**;
- Sealing flanges are arranged in **sealed glass sinterconnector**;
- Both are located on the load and transition rings of the main device.

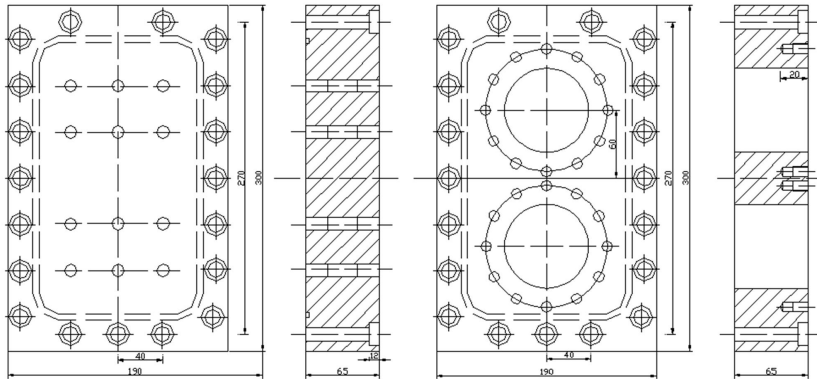

The diagram of sealing flanges  
in oil and line outlets

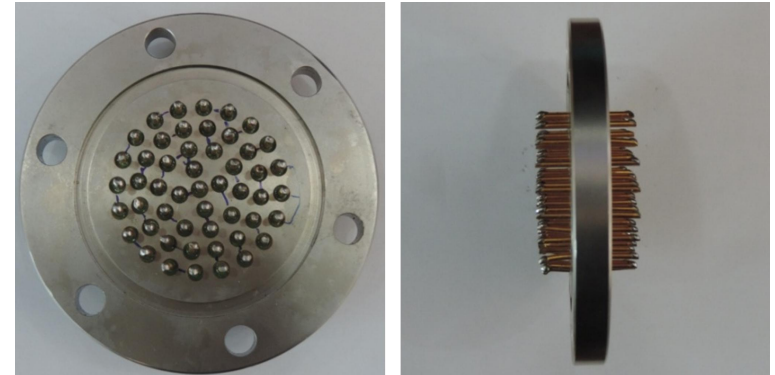

Sealed glass sinterconnector

## 3. Features of the system

### □ Multiple sealing designs

#### (3) Sealing at the simulated excavation opening

- Epoxy resin is coated on the sample end in radioactive ring;
- Glass silicone column is smeared between two layer of kraft papers;
- Two layers of 3 mm silicone boards are hanged on the inside of the front cover.

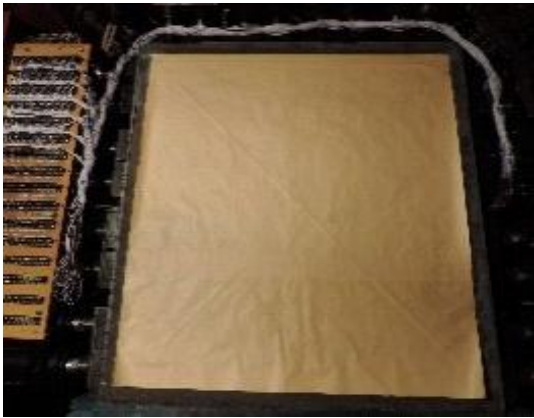

One sample end



Glass silicone column

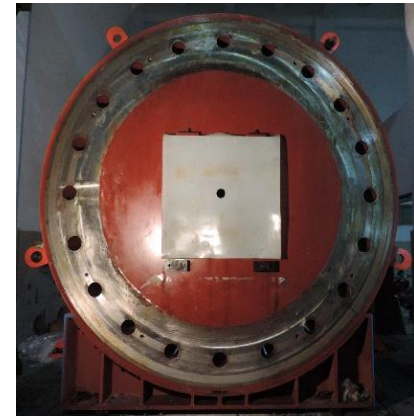

Silicone board

# 3. Features of the system

## True triaxial loading

- True triaxial load can be applied on the sample with the maximum loading stress of 10 MPa;
- Including 4 loading faces, 9 oil source channels, 72 loading units and 432 uniformly distributed oil cylinders;
- Uniform distribution of boundary load;
- The experimental model can be layered and stepped loaded.

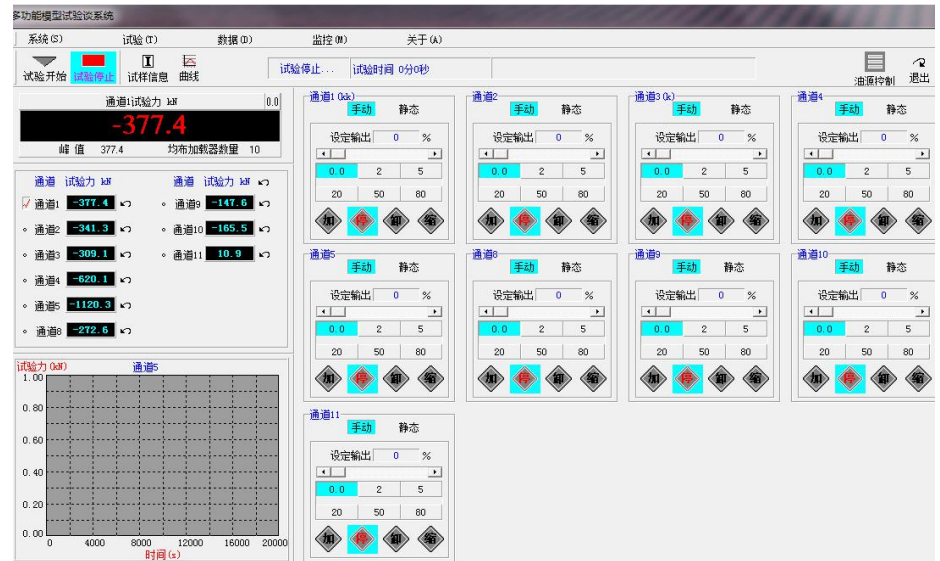
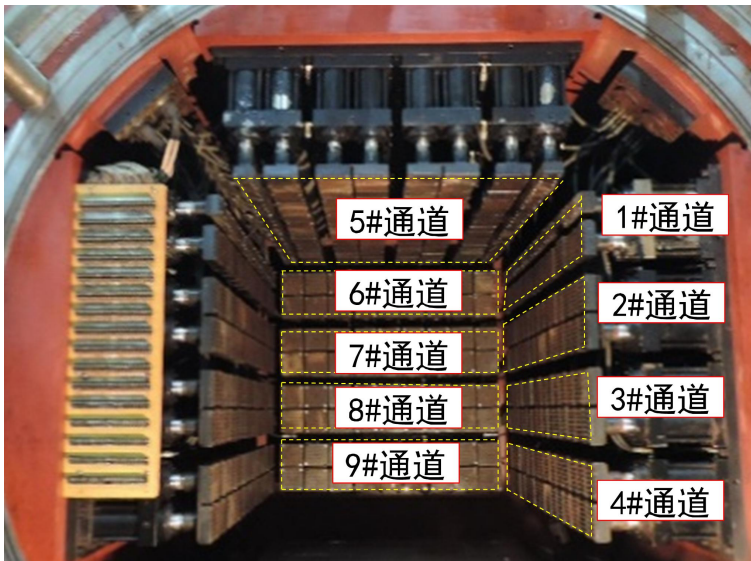

Hydraulic loading system

### 3. Features of the system

#### □ True triaxial loading

Set a layer of multi-porous and multi-groove **force transfer plate** between the loader pressure plate and tested sample.

- Solid stress is passed to the sample surface through the hopeless part
- Gas pressure is through the small holes

To **avoid the interference between air pressure and solid stress**, to ensure the effect of even inflating the sample, restoring the true boundaries of gas source.

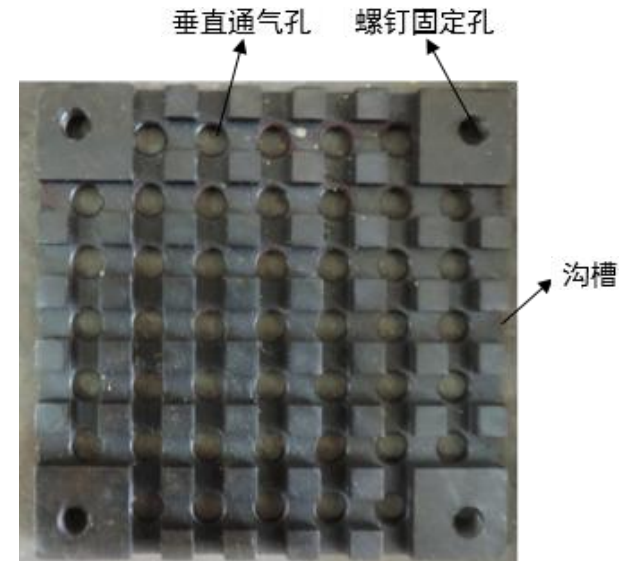

Uniform loader force transfer plate



### 3. Features of the system

#### □ Gas and solid pressure sensors

Both sensors are **independent** with each other.

The solid pressure sensor and the gas pressure sensor only measure the solid pressure and the gas pressure, respectively.



Solid pressure sensor

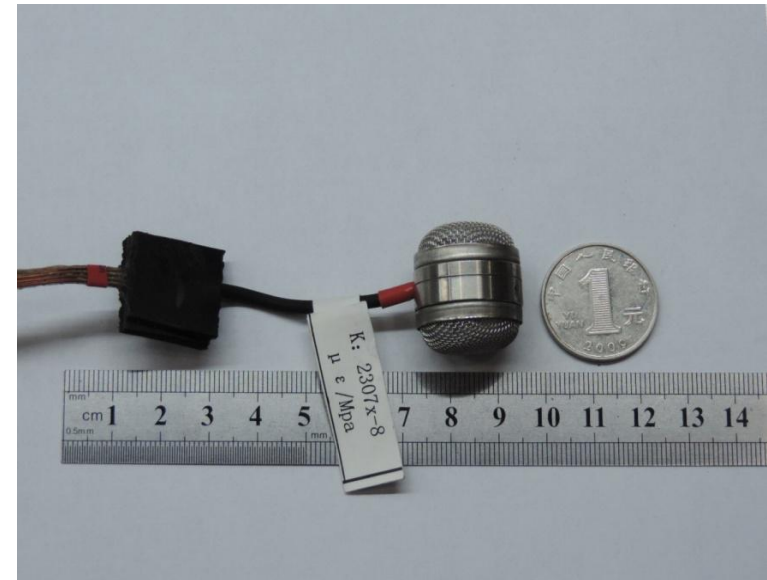

Gas pressure sensor

## 3. Features of the system

### □ Automatic simulated excavation

- The excavation device **automatically** simulates the excavation process;
- Adjustable in **X, Y and Z directions**;
- Restoring the disturbance behavior of underground excavation, ensuring the acquisition of **precursory information** of coal and gas outburst.

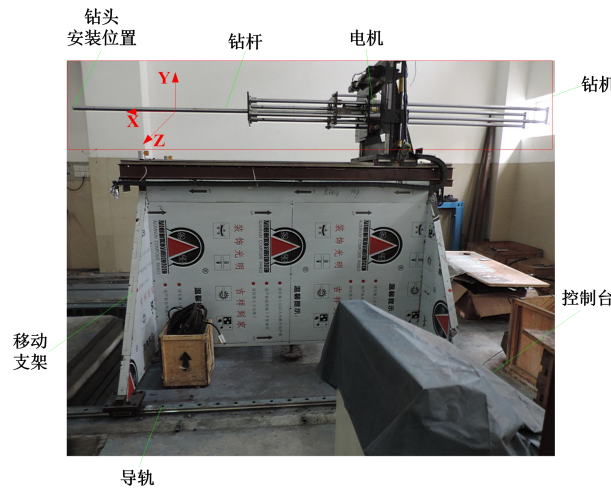

Simulated excavation device



# Outline

- 1. Introduction**
- 2. Development of coal and gas outburst experimental system**
- 3. Features of the system**
- 4. Coal and gas outburst simulation experiment**





## Simulated engineering background

+380 level N3# Cross cut of a coal mine in Chongqing, China

Parameter	Value
Burial depth	506 m
coal seam dip	55°
Coal thickness	3.83 m
Gas content	25.87 m <sup>3</sup> /t
Gas pressure	3 MPa

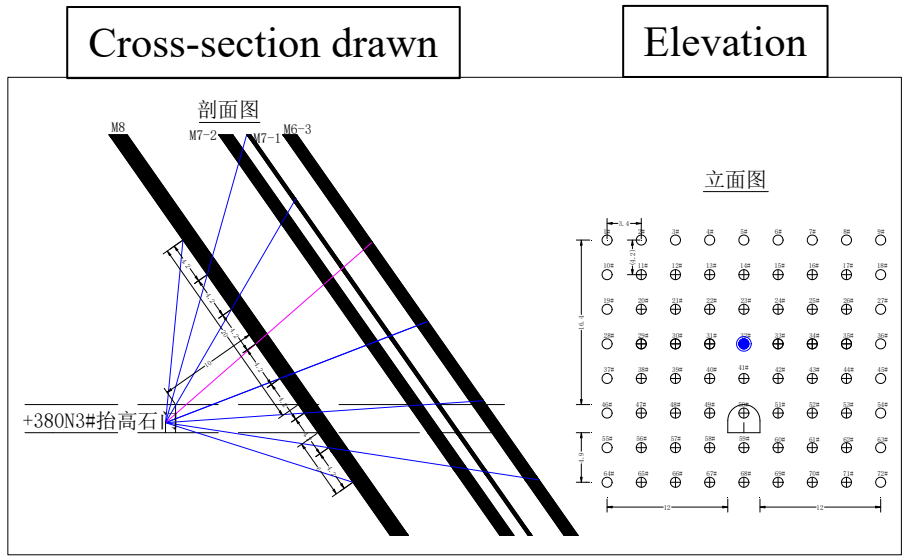

The in situ stress of N3# Cross cut

	Vertical stress /MPa	Maximum horizontal stress/MPa	Minimum horizontal stress /MPa
Value/MPa	12.65	17.71	11.44

## Experimental plan

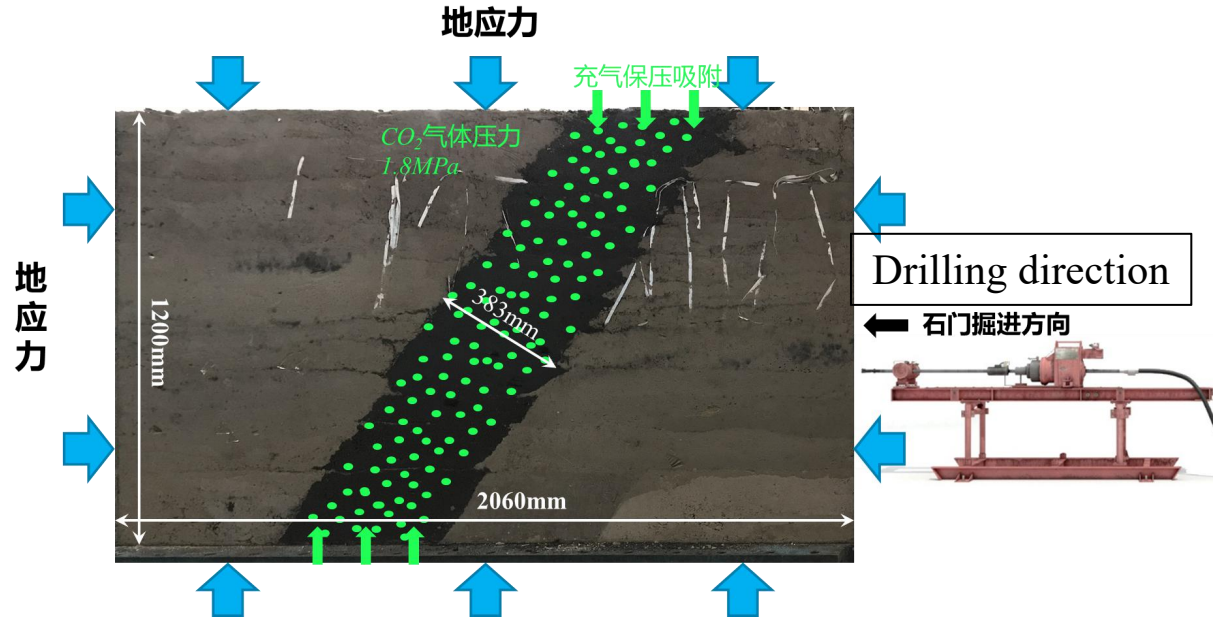

- Triaxial stresses were loaded to simulate **the stress state of coal in the stratum**;
- CO<sub>2</sub> was injected into the chamber at certain pressure to make the coal seam fully adsorbed, simulating **the gas in coal seam**;
- The drilling system was used to simulate **the excavation of cross-cut in coal mine**.

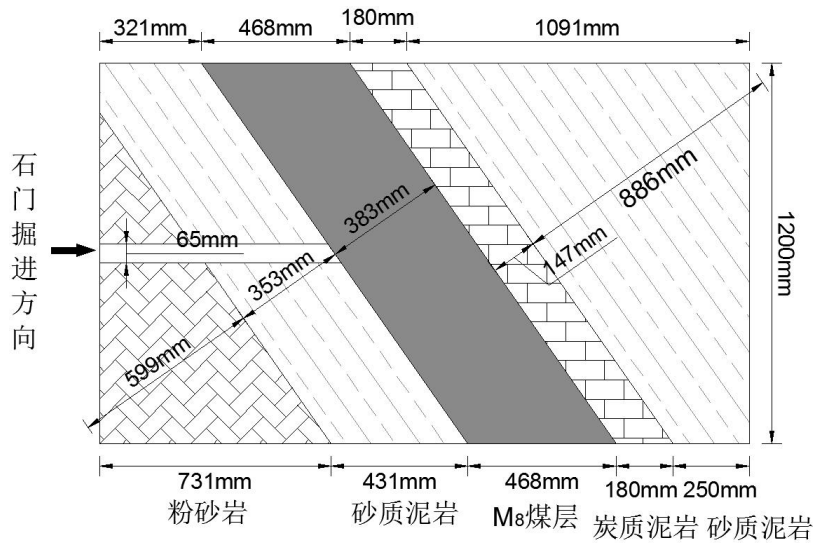

Schematic diagram of sample structure

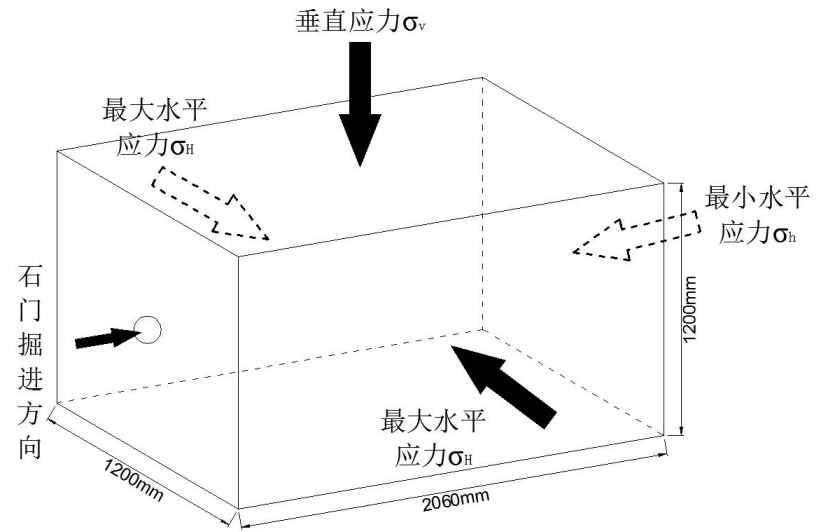

Schematic diagram of stress loading

Experimental loading stresses:

	Vertical stress /MPa	Maximum horizontal stress/MPa	Minimum horizontal stress /MPa
Value/MPa	4.2	5.9	3.8

**Gas pressure: 1.8 MPa (CO<sub>2</sub>)**



## □ Experimental procedures



Tamping Sample



Sensor embedding

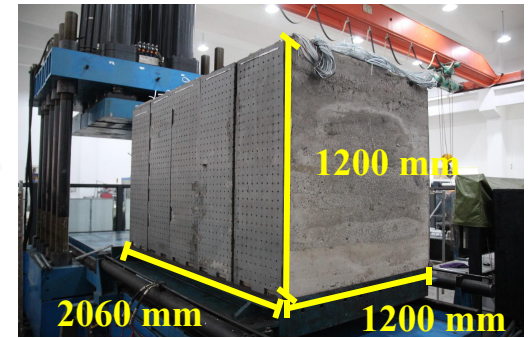

Created Specimen



Uncovering coal process



Sealing of whole setup

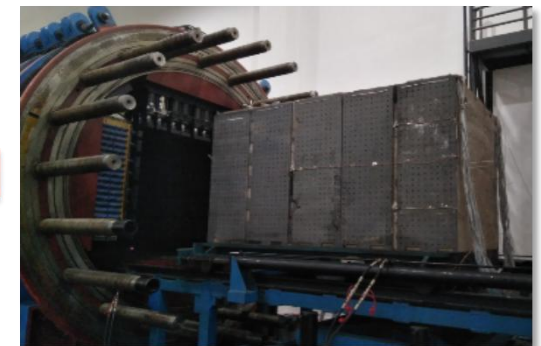

Sample transportation



## □ Outburst outcome



## Experimental data acquisition-Temperature

- In the gas injection and adsorption stage, the coal absorbed CO<sub>2</sub> and released heat, and the temperature raised rapidly;
- The overall temperature gradually decreased after adsorption saturation, because the heat release process stops;
- The gas injection was conducted in several steps, resulting in several peaks in the temperature variation of the coal.

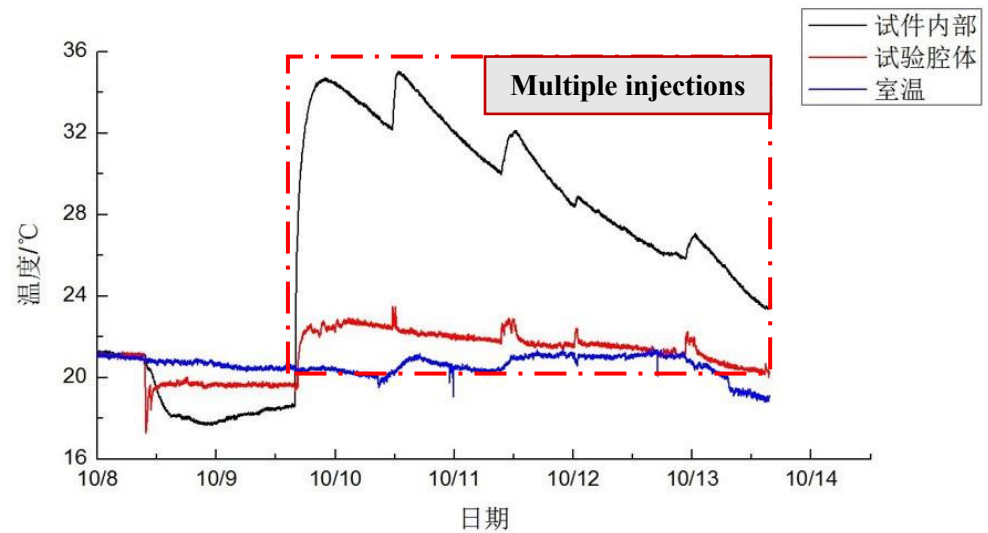

Temperature variation during testing

## Experimental data acquisition-AE signals

- The simulated excavation drilling was carried out **in multiple stages**, each drilling operation was carried out until the stress field of coal and rock was stable;
- the coal body broke through the protective rock pillar, coal and gas outburst occurred when there was still some distance between drilling hole and the coal seam;
- During the outburst stage of coal, coal powder erupted intermittently, presenting "**pulsating phenomenon**".

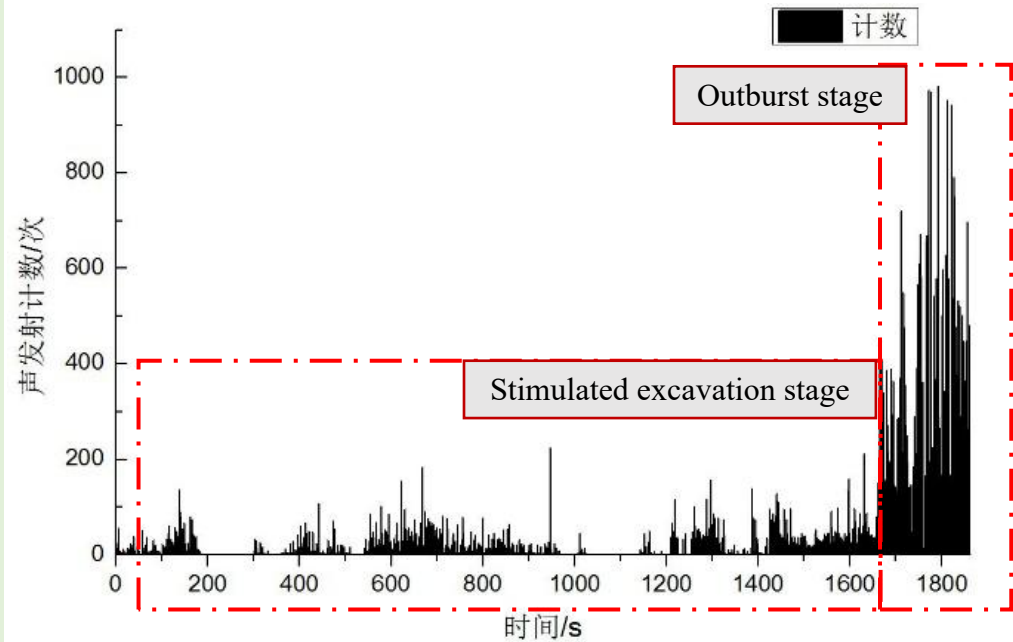

AE signals during testing

## Experimental data acquisition-Stress variation

- In the stage of stress loading, **the stress was loaded step by step**;
- In the simulated excavation stage, the stress concentration was generated during drilling;
- In the stage of outburst, coal powder was ejected, resulting in cavities inside the coal body and **a substantial reduction in solid pressure**.

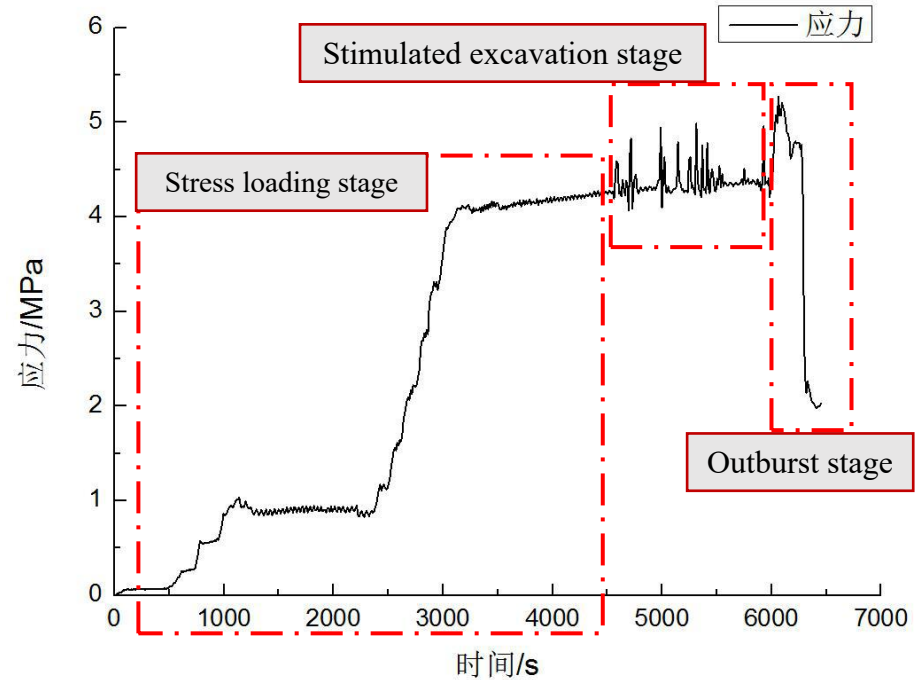

The stress variation during testing

## Experimental data acquisition-Gas pressure

- In the simulated excavation stage, little gas leaked from the excavation hole, and the gas pressure decreases slightly;
- In the stage of outburst, coal powder and gas were ejected at the same time, the coal mass connects with the outside air, **gas pressure drops sharply**;
- In the stage of burst, large amount of coal powder was ejected and block the hole mouth, resulting in fluctuation of gas pressure in the hole.

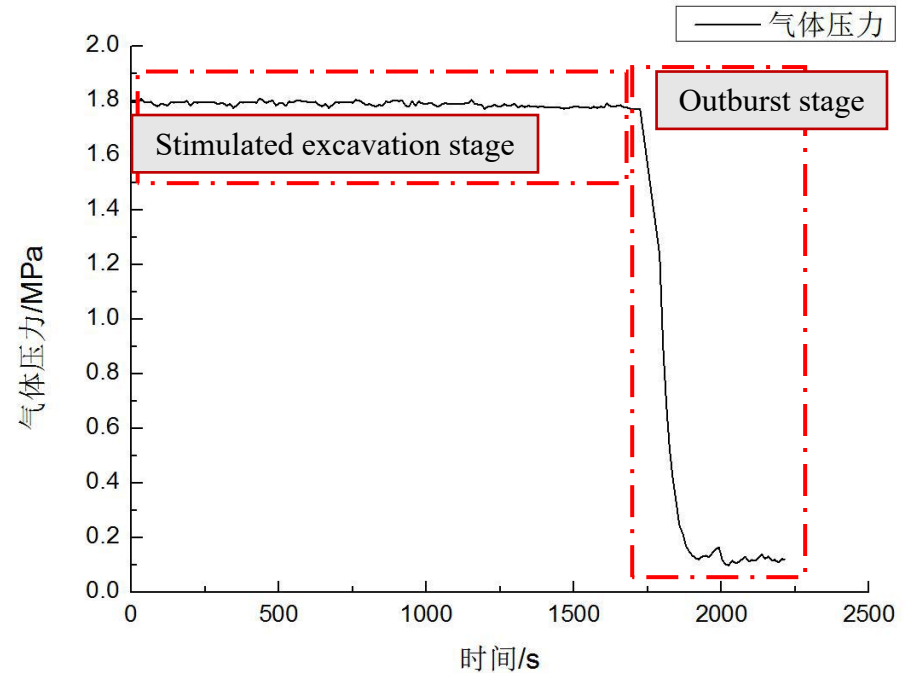

The gas pressure variation during testing

- ✓ The successfully development of “**Multi-functional physical model testing system of deep coal petrography engineering**” can satisfy the requirements of the physical model experiment of coal and rock mass engineering problems.
- ✓ The conduct of coal and gas outburst experiments provides scientific experimental basis for studying the occurrence mechanism, prediction method and control technology of coal and gas outburst in coal mine.



重慶大學

CHONGQING UNIVERSITY

# Thanks for your attention



SKL - CMD