

## 冲击危险性预测与评价技术

- 综合指数法
- 多因素耦合分析法
- 应力分析法

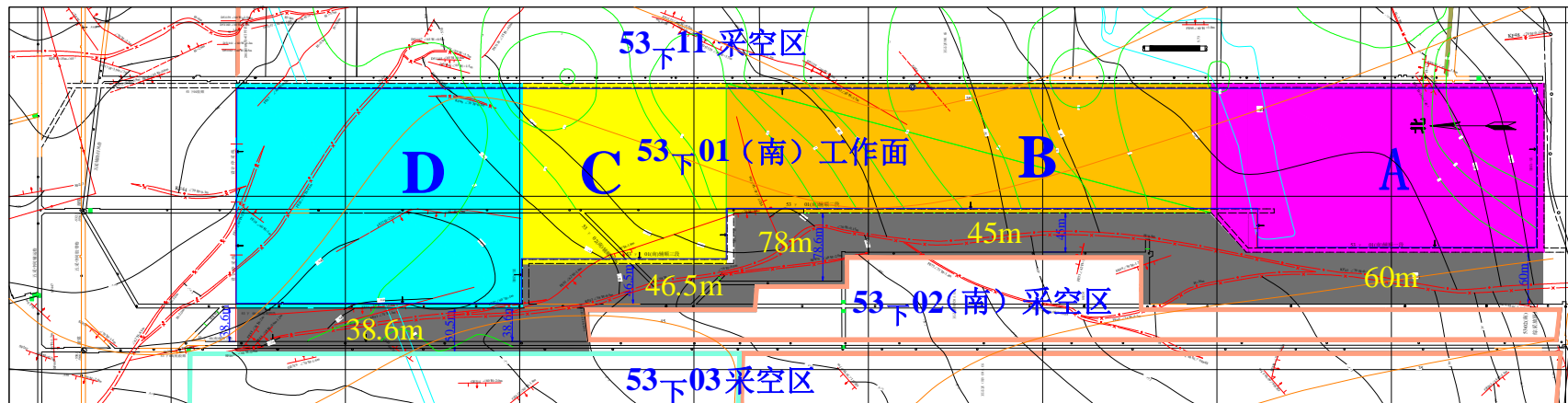

## 1.1) 综合指数法

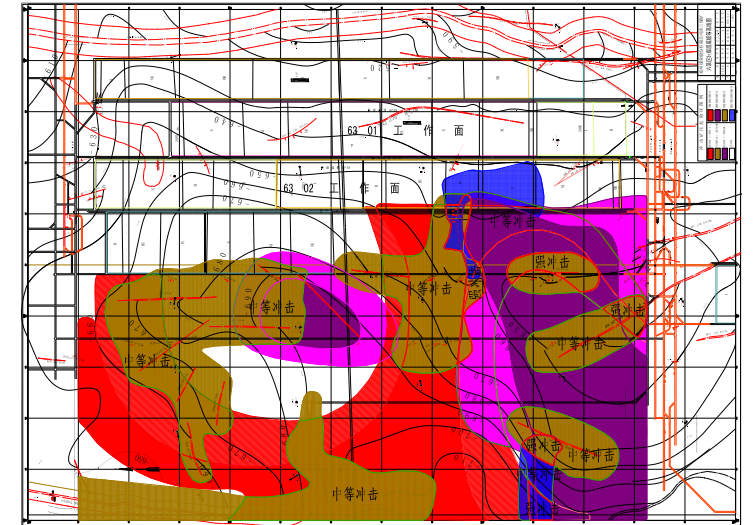

### □ 冲击矿压危险评价的综合指数法（2003）

- 地质因素确定冲击危险：主要考虑了冲击矿压发生的情况、开采深度、地质构造、坚硬顶板、顶板厚度特征参数、煤的冲击倾向性、煤的强度等7个因素。
- 开采因素确定冲击危险：主要考虑了开采技术条件、开采历史、煤柱、停采线、采空区、煤层的变化带、断层皱曲等12个开采因素对冲击矿压发生的影响

$$W_{t1} = \frac{\sum_{i=1}^7 X_i}{\sum_{i=1}^7 X_{i \max}}$$

$$W_{t2} = \frac{\sum_{i=1}^{12} X_i}{\sum_{i=1}^{12} X_{i \max}}$$

## 1.2) 多因素耦合分析法



State Key Laboratory  
of Coal Resources and Safe M



### □ 多因素耦合分析法

济三煤矿六采区冲击矿压危险区域分布

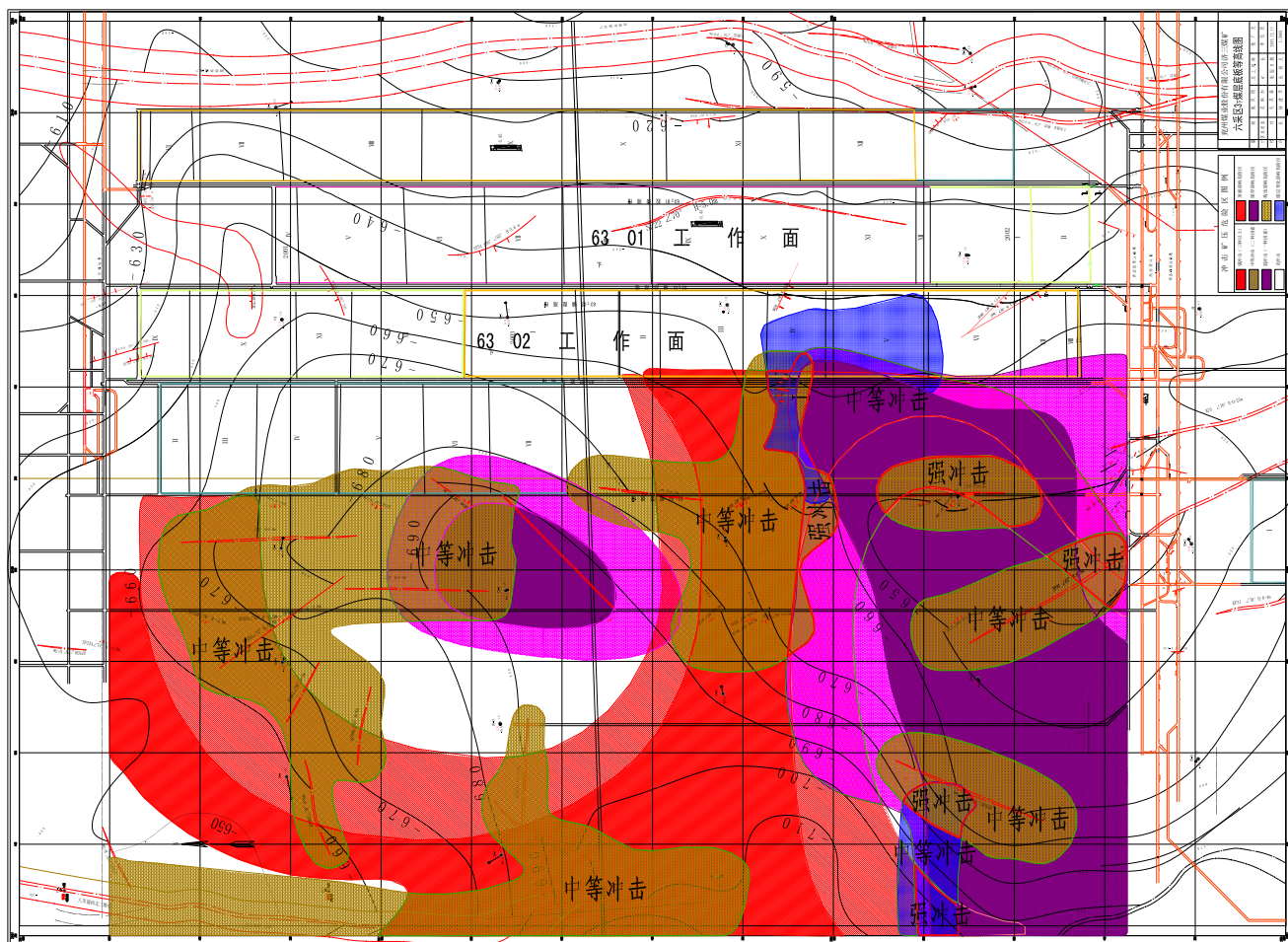

编号	影响因素
$W_1$	落差大于3m、小于10m的断层区域
$W_2$	倾角变化( $>15^\circ$ )褶曲区域
$W_3$	煤层侵蚀、合层或厚度变化区域
$W_4$	顶底板岩性变化区域
$W_5$	上保护层开采遗留的煤柱下方区域
$W_6$	落差大于10m的断层或断层群区域
$W_7$	向采空区推进的工作面
$W_8$	不规则采面或多个采面开切眼、停采线不齐区域
$W_9$	巷道交叉区域
$W_{10}$	沿空巷道煤柱
$W_{11}$	工作面超前支承压力区
$W_{12}$	老顶初次来压
$W_{13}$	工作面采空区“见方”区域
$W_{14}$	留底煤区域
$W_{15}$	采掘扰动区域

## 1.3) 应力分析法



State Key Laboratory  
of Coal Resources and Safe M



### □ 相对应力集中系数叠加法

影响冲击矿压发生的某因素引起的最大主应力与自重应力的比值，称为相对应力集中系数分量，用  $\delta_{ij}$  表示。各分量的乘积为该区域的相对应力集中系数，记为  $\delta_i$

危险等级	Rc<16MPa 判据	Rc<20MPa 判据
无冲击危险	$\delta_i < \frac{R_c}{\sigma_0}$	$\delta_i < \frac{R_c}{\sigma_0}$
弱冲击危险	$\frac{R_c}{\sigma_0} < \delta_i < \frac{70}{\sigma_0}$	$\frac{R_c}{\sigma_0} < \delta_i < \frac{50}{\sigma_0}$
中等冲击危险	$\frac{70}{\sigma_0} < \delta_i < \frac{90}{\sigma_0}$	$\frac{50}{\sigma_0} < \delta_i < \frac{70}{\sigma_0}$
强冲击危险	$\delta_i > \frac{90}{\sigma_0}$	$\delta_i > \frac{70}{\sigma_0}$

# 1.3) 应力分析法



State Key Laboratory of Coal Resources and Safe Mining



## □ 应力分析法 (2011)

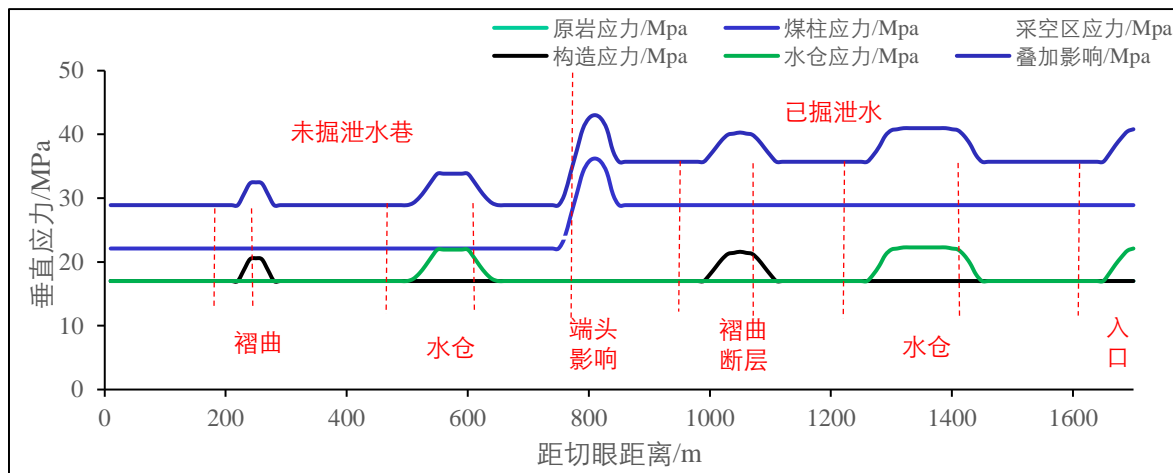
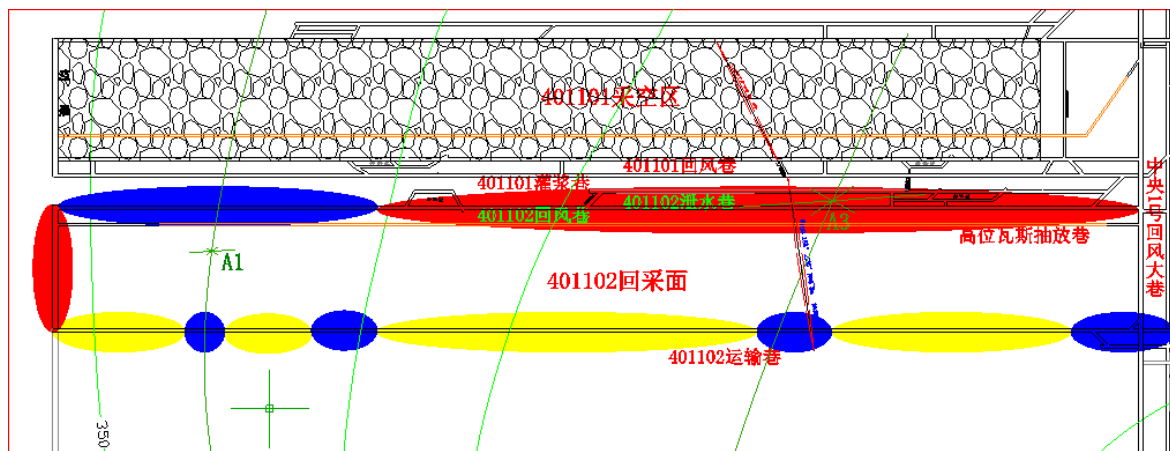

掘进期间主控因素及应力叠加法

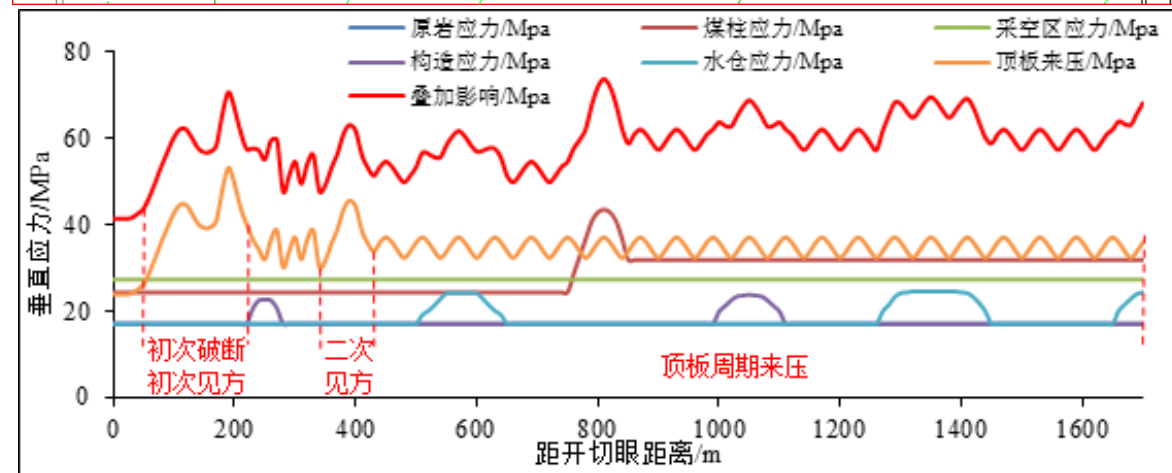
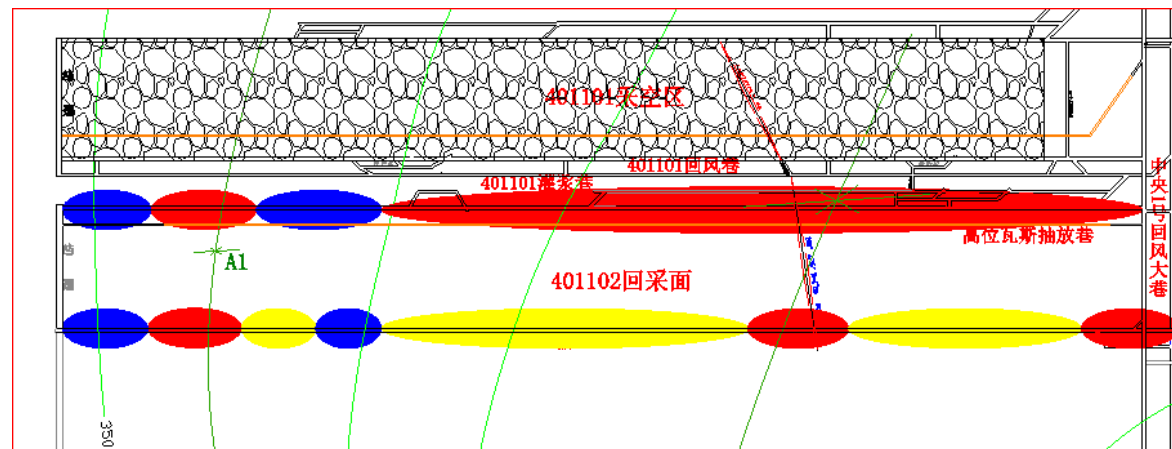

回采期间主控因素及应力叠加法

# 1.3) 应力分析法

## □ 应力分析法

